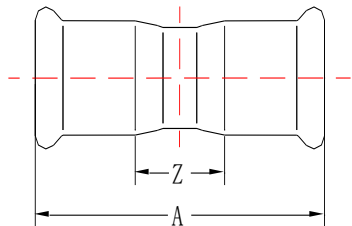
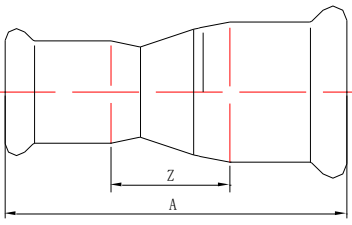
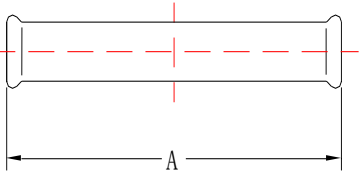

燃气管道系统产品

燃气管道系统产品（管材）				
	产品代码 Code	公称通径 (mm)	覆塑厚度 (mm)	壁厚 (mm)
	FLT1015-5	15	0.8	0.8
	FLT1020-5	20	0.8	1.0
	FLT1025-5	25	0.8	1.0

燃气管道系统产品（管件）

1	等径对接头 Coupling	产品代号 Type-Code	产品代码 Code	公称通径 Nominal.dia (mm)	A (mm)	Z (mm)
	SC	FLTA01150000	15	55	17	
		FLTA01200000	20	63	21	
		FLTA01250000	25	63	21	
		FLTA01320000	32	100	28	
		FLTA01400000	40	116	28	
		FLTA01500000	50	126	28	
		大规格 Super size				
		FLTA01650000	65	141	35	
		FLTA01800000	80	162	42	
		FLTA01100000	100	194	44	
2	异径对接头 Reducer	产品代号 Type-Code	产品代码 Code	公称通径 Nominal.dia (mm)	A (mm)	Z (mm)
	RC	FLTA02201500	20×15	61	21	
		FLTA02251500	25×15	72	32	
		FLTA02252000	25×20	65	23	
		FLTA02321500	32×15	98	43	
		FLTA02322000	32×20	91	34	
		FLTA02322500	32×25	82	25	
		FLTA02401500	40×15	119	56	
		FLTA02402000	40×20	112	47	
		FLTA02402500	40×25	103	38	
		FLTA02403200	40×32	112	32	

			FLTA02501500	50×15	133	65
			FLTA02502000	50×20	127	57
			FLTA02502500	50×25	117	47
			FLTA02503200	50×32	126	41
			FLTA02504000	50×40	121	28
			大规格 Super size			
			FLTA02652000	65x20	129	55
			FLTA02652500	65x25	122	48
			FLTA02653200	65x32	139	50
			FLTA02654000	65x40	144	47
			FLTA02655000	65x50	148	46
			FLTA02802000	80x20	143	62
			FLTA02802500	80x25	136	55
			FLTA02803200	80x32	153	57
			FLTA02804000	80x40	158	54
			FLTA02805000	80x50	162	53
			FLTA02806500	80x65	161	48
			FLTA02100200	100x20	164	68
			FLTA02100250	100x25	157	61
			FLTA02100320	100x32	175	64
			FLTA02100400	100x40	180	61
			FLTA02100500	100x50	183	59
			FLTA02100650	100x65	182	54
			FLTA02100800	100x80	190	55
3	可调对接头 Slip coupling	产品代号 Type-Code	产品代码 Code	公称通径 Nominal.dia (mm)	A (mm)	
		KC	FLTA03150000	15	116	
			FLTA03200000	20	129	
			FLTA03250000	25	129	
			FLTA03320000	32	100	
			FLTA03400000	40	116	
			FLTA03500000	50	126	
			大规格 Super size			
			FLTA03650000	65	230	
			FLTA03800000	80	260	
			FLTA03100000	100	310	
4			A 型 90°弯头 90°elbow	产品代号 Type-Code	产品代码 Code	公称通径 Nominal.dia (mm)

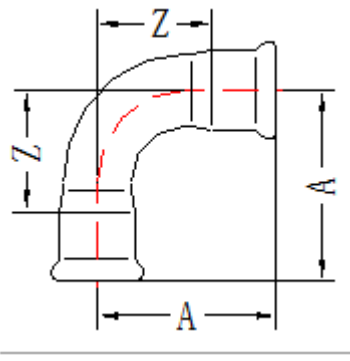
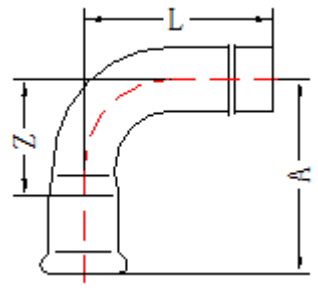
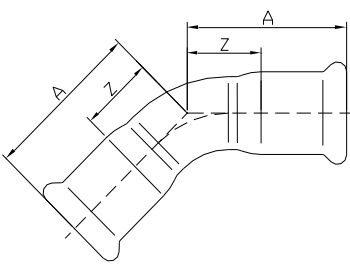
		90E (A)	FLTA04150000	15	48	29	
			FLTA04200000	20	58	37	
			FLTA04250000	25	66	45	
			FLTA04320000	32	91	55	
			FLTA04400000	40	110	66	
			FLTA04500000	50	122	73	
			大规格 Super size				
			FLTA04650000	65	193	140	
			FLTA04800000	80	223	163	
			FLTA04100000	100	260	185	
5	B 型 90°弯头 90°elbow with one plain end	产品代号 Type-Code	产品代码 Code	公称通径 Nominal.dia (mm)	A (mm)	Z (mm)	L (mm)
		90E (B)	FLTA05150000	15	48	29	120
			FLTA05200000	20	58	37	127
			FLTA05250000	25	66	45	135
			FLTA05320000	32	91	66	241
			FLTA05400000	40	110	66	252
			FLTA05500000	50	122	73	259
			大规格 Super size				
			FLTA05650000	65	193	140	247
			FLTA05800000	80	215	155	292
			FLTA05100000	100	260	185	358
6	A 型 45°弯头 45°elbow	产品代号 Type-Code	产品代码 Code	公称通径 Nominal.dia (mm)	A (mm)	Z (mm)	
		45E (A)	FLTA06150000	15	35	16	
			FLTA06200000	20	42	21	
			FLTA06250000	25	45	24	
			FLTA06320000	32	66	30	
			FLTA06400000	40	78	34	
			FLTA06500000	50	86	38	
			大规格 Super size				
			FLTA06650000	65	120	67	
			FLTA06800000	80	139	79	
			FLTA06100000	100	163	88	
7	B 型 45°弯头 45°elbow with one plain end	产品代号 Type-Code	产品代码 Code	公称通径 Nominal.dia (mm)	A (mm)	Z (mm)	L (mm)
		45E (B)	FLTA07150000	15	35	16	113

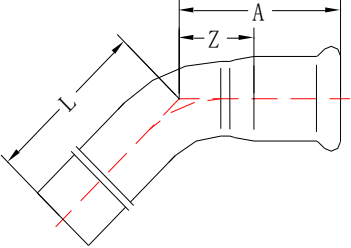
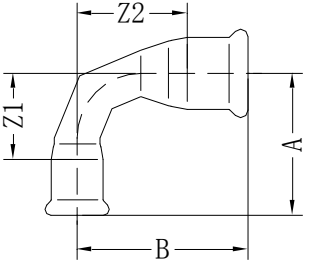
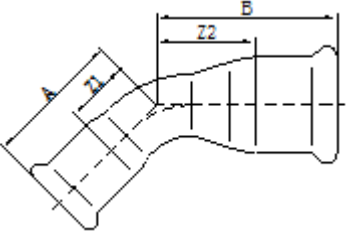
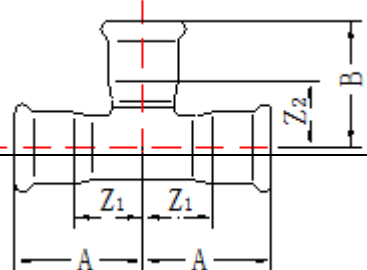
		FLTA07200000	20	42	21	117		
		FLTA07250000	25	45	24	120		
		FLTA07320000	32	66	30	217		
		FLTA07400000	40	78	34	222		
		FLTA07500000	50	86	38	225		
		大规格 Super size						
		FLTA07650000	65	120	67	188		
		FLTA07800000	80	139	79	225		
		FLTA07100000	100	164	89	275		
8	异径 90°弯头 90° elbow	产品代号 Type-Code	产品代码 Code	公称通径 Nominal.dia (mm)	A (mm)	B (mm)	Z1 (mm)	Z2 (mm)
		R90E	FLTA08201500	20x15	48	57	29	36
			FLTA08251500	25x15	48	69	29	48
			FLTA08252000	25x20	58	67	37	46
			FLTA08322000	32x20	58	106	37	70
			FLTA08322500	32x25	66	90	45	54
			FLTA08402000	40x20	58	113	37	69
			FLTA08402500	40x25	58	103	37	59
			FLTA08403200	40x32	91	110	55	66
			FLTA08502000	50x20	58	127	37	78
			FLTA08502500	50x25	58	117	37	68
			FLTA08504000	50x40	110	121	66	72
9	异径 45°弯头 45° elbow	产品代号 Type-Code	产品代码 Code	公称通径 Nominal.dia (mm)	A (mm)	B (mm)	Z1 (mm)	Z2 (mm)
		R45E	FLTA09201500	20x15	35	44	16	23
10	等径三通接头 Equal tee	产品代号 Type-Code	产品代码 Code	公称通径 Nominal.dia (mm)	A (mm)	B (mm)	Z1 (mm)	Z2 (mm)
		T(S)	FLTA10150000	15	38	37	19	18
			FLTA10200000	20	46	44	25	23
			FLTA10250000	25	51	47	30	26
			FLTA10320000	32	70	69	34	33

			FLTA10400000	40	82	81	38	37
			FLTA10500000	50	90	89	41	40
			大规格 Super size					
			FLTA10650000	65	115	109	62	56
			FLTA10800000	80	130	126	70	66
			FLTA10100000	100	155	152	80	77
11	异径三通接头 Reducing tee	产品代号 Type-Code	产品代码 Code	公称通径 Nominal.dia (mm)	A (mm)	B (mm)	Z1 (mm)	Z2 (mm)
			FLTA11201500	20×15	46	49	25	30
			FLTA11251500	25×15	51	52	30	33
			FLTA11252000	25×20	52	47	30	26
			FLTA11321500	32×15	70	57	34	38
			FLTA11322000	32×20	70	56	34	35
			FLTA11322500	32×25	70	63	34	42
			FLTA11401500	40×15	82	61	38	42
			FLTA11402000	40×20	82	60	38	39
			FLTA11402500	40×25	82	67	38	46
			FLTA11403200	40×32	82	81	38	45
			FLTA11501500	50×15	90	64	41	45
			FLTA11502000	50×20	90	63	41	42
			FLTA11502500	50×25	90	70	41	49
			FLTA11503200	50×32	90	84	41	48
			FLTA11504000	50×40	90	94	41	50
			大规格 Super size					
			FLTA11652000	65x20	115	78	62	57
			FLTA11652500	65x25	115	84	62	63
			FLTA11653200	65x32	115	97	62	61
			FLTA11654000	65x40	115	107	62	63
			FLTA11655000	65x50	115	128	62	79
			FLTA11802000	80x20	130	84	70	63
			FLTA11802500	80x25	130	90	70	69
			FLTA11803200	80x32	130	104	70	68
			FLTA11804000	80x40	130	114	70	70
			FLTA11805000	80x50	130	135	70	86
			FLTA11806500	80x65	130	116	70	63
			FLTA11100200	100x20	155	94	80	73
			FLTA11100250	100x25	155	100	80	79
			FLTA11100320	100x32	155	113	80	77

T(R)

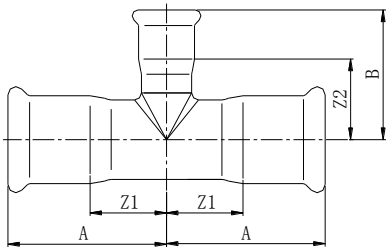

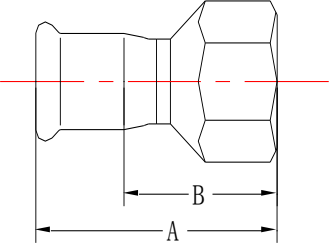
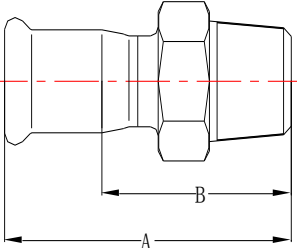
			FLTA11100400	100x40	155	123	80	79	
			FLTA11100500	100x50	155	144	80	95	
			FLTA11100650	100x65	155	126	80	73	
			FLTA11100800	100x80	155	136	80	76	
12	内螺纹转换接头 Female adapter (Rp)	产品代号 Type-Code	产品代码 Code	公称通径 Nominal.dia (mmxRp)	A (mm)	B (mm)			
		ITC	FLTA12150100	15×Rp ¹ / ₂	52	33			
			FLTA12200100	20×Rp ¹ / ₂	58	37			
			FLTA12200200	20×Rp ³ / ₄	60	39			
			FLTA12250100	25×Rp ¹ / ₂	61	40			
			FLTA12250200	25×Rp ³ / ₄	64	43			
			FLTA12250300	25×Rp1	60	39			
			FLTA12320300	32×Rp1	79	43			
			FLTA12320400	32×Rp1 ¹ / ₄	89	53			
			FLTA12400400	40×Rp1 ¹ / ₄	87	43			
			FLTA12400500	40×Rp1 ¹ / ₂	98	54			
			FLTA12500300	50xRp1	110	61			
			FLTA12500400	50×Rp1 ¹ / ₄	97	48			
			FLTA12500500	50×Rp1 ¹ / ₂	93	44			
			FLTA12500600	50×Rp2	110	61			
			大规格 Super size						
			FLTA12650700	65×Rp1 ¹ / ₂	109	56			
			FLTA12800800	80xRp3	121	61			
	FLTA12100090	100xRp4	143	68					
13	外螺纹转换接头 Male adapter	产品代号 Type-Code	产品代码 Code	公称通径 Nominal.dia (mmxR)	A (mm)	B (mm)			
		ETC	FLTA13150100	15×R ¹ / ₂	56	37			
			FLTA13200100	20×R ¹ / ₂	62	41			
			FLTA13200200	20×R ³ / ₄	63	42			
			FLTA13250300	25×R1	68	47			
			FLTA13320300	32×R1	87	51			
			FLTA13320400	32×R1 ¹ / ₄	104	68			
			FLTA13400400	40×R1 ¹ / ₄	97	53			
			FLTA13400500	40×R1 ¹ / ₂	112	68			
			FLTA13500500	50×R1 ¹ / ₂	106	57			
			FLTA13500600	50×R2	128	79			
			大规格 Super size						

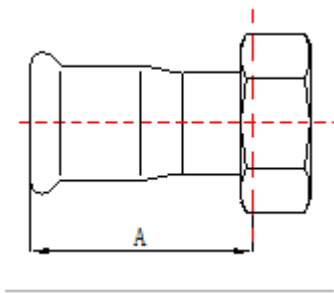
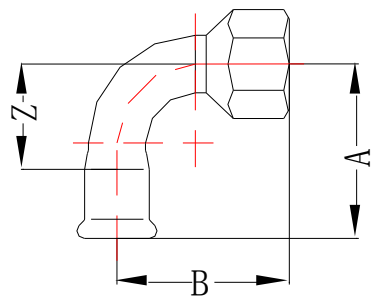
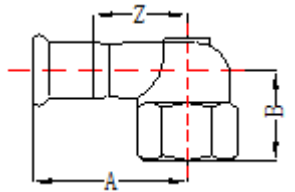
			FLTA13650700	65×R2 ¹ / ₂	123	70		
			FLTA13800800	80×R3	137	77		
			FLTA13100090	100×R4	161	86		
14	螺母移动转换接头 Valve connector	产品代号 Type-Code	产品代码 Code	公称通径 Nominal.dia (mmxG)	A (mm)			
		ZL	FLTA14150100	15×G ¹ / ₂	38			
			FLTA14150200	15×G ³ / ₄	41			
			FLTA14200100	20×G ¹ / ₂	47			
			FLTA14200200	20×G ³ / ₄	50			
			FLTA14250300	25×G1	52			
			FLTA14320400	32×G1 ¹ / ₄	64			
			FLTA14400500	40×G1 ¹ / ₂	82			
			FLTA14500600	50×G2	77			
15	内螺纹 90° 转换弯头(长型) 90° female angle adapter (long) (Rp)	产品代号 Type-Code	产品代码 Code	公称通径 Nominal.dia (mmxRp)	A (mm)	B (mm)	Z (mm)	
		ITC90E ₁	FLTA15150100	15×Rp ¹ / ₂	48	49	29	
			FLTA15200100	20×Rp ¹ / ₂	58	57	37	
			FLTA15200200	20×Rp ³ / ₄	58	59	37	
			FLTA15250200	25×Rp ³ / ₄	58	62	37	
			FLTA15250300	25×Rp1	66	67	45	
			FLTA15320300	32×Rp1	91	75	55	
			FLTA15320400	32×Rp1 ¹ / ₄	91	85	55	
			FLTA15400400	40×Rp1 ¹ / ₄	110	86	66	
			FLTA15400500	40×Rp1 ¹ / ₂	110	97	66	
			FLTA15500500	50×Rp1 ¹ / ₂	122	94	73	
			FLTA15500600	50×Rp2	122	111	73	
16	内螺纹 90° 转换弯头(短型) 90° female angle adapter (short) (Rp)	产品代号 Type-Code	产品代码 Code	公称通径 Nominal.dia (mmxRp)	A (mm)	B (mm)	Z (mm)	
		ITC90E ₂ (水栓用)	FLTA16150100	15×Rp ¹ / ₂	48	28	29	
			FLTA16200100	20×Rp ¹ / ₂	52	31	31	
			FLTA16200200	20×Rp ³ / ₄	56	35	35	
17	外螺纹 90° 转换弯头 90° male angle adapter	产品代号 Type-Code	产品代码 Code	公称通径 Nominal.dia (mmxR)	A (mm)	B (mm)	Z (mm)	

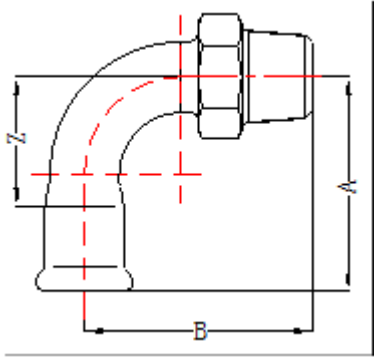
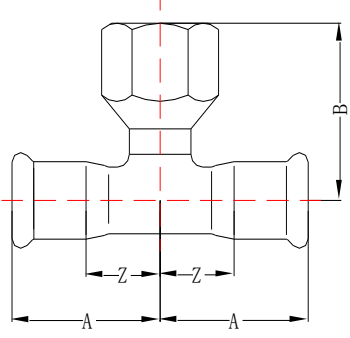
	ETC90E	FLTA17150100	15×R ¹ / ₂	48	53	29		
		FLTA17200100	20×R ¹ / ₂	58	61	37		
		FLTA17200200	20×R ³ / ₄	58	62	37		
		FLTA17250300	25×R1	66	75	45		
		FLTA17320300	32×R1	91	83	55		
		FLTA17320400	32×R1 ¹ / ₄	91	100	55		
		FLTA17400400	40×R1 ¹ / ₄	110	96	66		
		FLTA17400500	40×R1 ¹ / ₂	110	111	66		
		FLTA17500500	50×R1 ¹ / ₂	122	107	73		
		FLTA17500600	50×R2	122	129	73		
18	内螺纹三通转换接头 Branch tee female outlet (Rp)	产品代号 Type-Code	产品代码 Code	公称通径 Nominal.dia (mm×Rp)	A (mm)	B (mm)	Z (mm)	
	ITCT	FLTA18150100	15×Rp ¹ / ₂	38	42	19		
		FLTA18200100	20×Rp ¹ / ₂	46	45	25		
		FLTA18200200	20×Rp ³ / ₄	46	47	25		
		FLTA18250100	25×Rp ¹ / ₂	51	48	30		
		FLTA18250200	25×Rp ³ / ₄	51	51	30		
		FLTA18250300	25×Rp1	51	53	30		
		FLTA18320100	32×Rp ¹ / ₂	70	51	34		
		FLTA18320200	32×Rp ³ / ₄	70	54	34		
		FLTA18320300	32×Rp1	70	50	34		
		FLTA18320400	32×Rp1 ¹ / ₄	70	60	34		
		FLTA18400100	40×Rp ¹ / ₂	82	55	38		
		FLTA18400200	40×Rp ³ / ₄	82	58	38		
		FLTA18400300	40×Rp1	82	54	38		
		FLTA18400400	40×Rp1 ¹ / ₄	82	54	38		
		FLTA18400500	40×Rp1 ¹ / ₂	82	65	38		
		FLTA18500100	50×Rp ¹ / ₂	90	58	41		
		FLTA18500200	50×Rp ³ / ₄	90	61	41		
		FLTA18500300	50×Rp1	90	57	41		
		FLTA18500500	50×Rp1 ¹ / ₂	90	58	41		
		FLTA18500600	50×Rp2	90	75	41		
		大规格 Super size						
		FLTA18650200	65×Rp3/4	115	75	62		
		FLTA18650300	65×Rp2	115	89	62		
		FLTA18800200	80×Rp3/4	130	82	70		
FLTA18800300	80×Rp2	130	96	70				
FLTA18100020	100×Rp3/4	155	91	80				

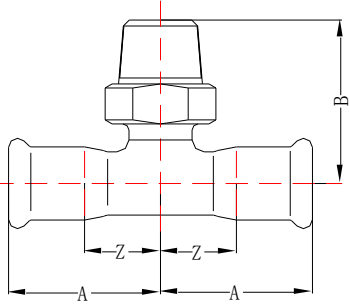
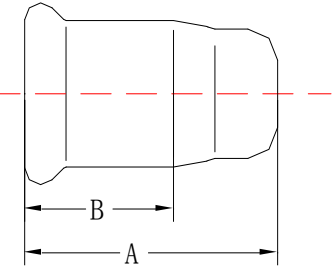
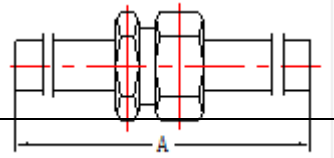
			FLTA18100030	100×Rp2	155	105	80	
19	外螺纹三通转换接头 Branch tee male outlet	产品代号 Type-Code	产品代码 Code	公称通径 Nominal.dia (mm×R)	A (mm)	B (mm)	Z (mm)	
		ETGT	FLTA19150100	15×R ¹ / ₂	38	41	19	
			FLTA19200100	20×R ¹ / ₂	46	46	25	
			FLTA19200200	20×R ³ / ₄	46	47	25	
			FLTA19250100	25×R ¹ / ₂	51	49	30	
			FLTA19250200	25×R ³ / ₄	51	50	30	
			FLTA19250300	25×R1	51	55	30	
			FLTA19320200	32×R ³ / ₄	75	53	39	
			FLTA19320300	32×R1	75	58	39	
			FLTA19320400	32×R1 ¹ / ₄	75	75	39	
			FLTA19400200	40×R ³ / ₄	88	57	44	
			FLTA19400300	40×R1	88	62	44	
			FLTA19400400	40×R1 ¹ / ₄	88	64	44	
			FLTA19400500	40×R1 ¹ / ₂	88	79	44	
			FLTA19500200	50×R ³ / ₄	95	60	46	
			FLTA19500300	50×R1	95	65	46	
			FLTA19500500	50×R1 ¹ / ₂	95	71	46	
	FLTA19500600	50×R2	95	93	46			
20	管帽 Cap	产品代号 Type-Code	产品代码 Code	公称通径 Nominal.dia (mm)	A (mm)	B (mm)		
		CAP	FLTA20150000	15	31	19		
			FLTA20200000	20	36	21		
			FLTA20250000	25	37	21		
			FLTA20320000	32	59	36		
			FLTA20400000	40	66	44		
			FLTA20500000	50	74	49		
			大规格 Super size					
			FLTA20650000	65	84	53		
			FLTA20800000	80	91	60		
			FLTA20100000	100	110	75		
21	直管式活接头 Straight union connector	产品代号 Type-Code	产品代码 Code	公称通径 Nominal.dia (mm)	A (mm)			
		HJG	FLTA21150000	15	164			
			FLTA21200000	20	184			

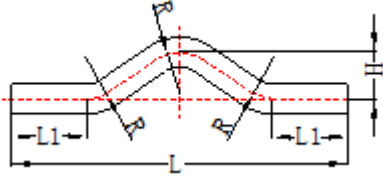
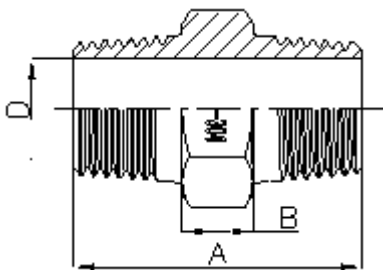
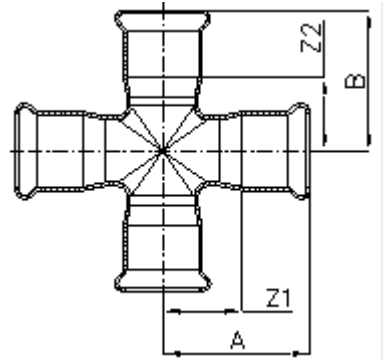
			FLTA21250000	25	204					
22	管桥 Pipebridge	产品代号 Type-Code	产品代码 Code	公称通径 Nominal.dia (mm)	L (mm)	H (mm)	L1 (mm)	R (mm)		
	B		FLTA23150000	15	172	25	40	22		
			FLTA23200000	20	201	30	40	28		
			FLTA23250000	25	268	40	54	36		
23	双外螺纹接头	产品代号 Type-Code	产品代码 Code	公称通径 Nominal.dia (mmxR)	A (mm)	B (mm)	D (mm)			
	SETC		FLTA26150100	15×R ¹ / ₂	41	10	14.2			
			FLTA26200200	20×R ³ / ₄	46	10	19			
			FLTA26250300	25xR1	50	13	25			
			FLTA26320400	32×R1 ¹ / ₄	55	13	33			
			FLTA26400500	40×R1 ¹ / ₂	55	13	39			
			FLTA26500600	50xR2	66	16	50			
			FLTA26650700	65×Rp2 ¹ / ₂	70	20	66			
24	等径四通接头	产品代号 Type-Code	产品代码 Code	公称通径 Nominal.dia (mm)	A (mm)	B (mm)	Z1 (mm)	Z2 (mm)		
	X(S)		FLTA27150000	15	38	37	19	18		
			FLTA27200000	20	46	44	25	23		
			FLTA27250000	25	51	47	30	26		
			FLTA27320000	32	70	69	34	33		
			FLTA27400000	40	82	81	38	37		
			FLTA27500000	50	90	89	41	40		
		大规格 Super size								
			FLTA27650000	65	115	109	62	56		
			FLTA27800000	80	130	126	70	66		
			FLTA27100000	100	155	152	80	77		
25	异径四通接头	产品代号 Type-Code	产品代码 Code	公称通径 Nominal.dia (mm)	A (mm)	B (mm)	Z1 (mm)	Z2 (mm)		
	X(R)		FLTA28201500	20x15	46	49	25	30		
			FLTA28251500	25x15	51	52	30	33		
			FLTA28252000	25x20	52	47	30	26		
			FLTA28321500	32x15	70	57	34	38		
			FLTA28322000	32x20	70	56	34	35		

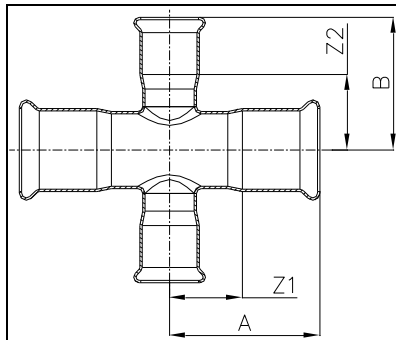

FLTA28322500	32x25	70	63	34	42
FLTA28401500	40x15	82	61	38	42
FLTA28402000	40x20	82	60	38	39
FLTA28402500	40x25	82	67	38	46
FLTA28403200	40x32	82	81	38	45
FLTA28501500	50x15	90	64	41	45
FLTA28502000	50x20	90	63	41	42
FLTA28502500	50x25	90	70	41	49
FLTA28503200	50x32	90	84	41	48
FLTA28504000	50x40	90	94	41	50
大规格 Super size					
FLTA28652000	65x20	115	78	62	57
FLTA28652500	65x25	115	84	62	63
FLTA28653200	65x32	115	97	62	61
FLTA28654000	65x40	115	107	62	63
FLTA28655000	65x50	115	128	62	79
FLTA28802000	80x20	130	84	70	63
FLTA28802500	80x25	130	90	70	69
FLTA28803200	80x32	130	104	70	68
FLTA28804000	80x40	130	114	70	70
FLTA28805000	80x50	130	135	70	86
FLTA28806500	80x65	130	116	70	63
FLTA28100200	100x20	155	94	80	73
FLTA28100250	100x25	155	100	80	79
FLTA28100320	100x32	155	113	80	77
FLTA28100400	100x40	155	123	80	79
FLTA28100500	100x50	155	144	80	95
FLTA28100650	100x65	155	126	80	73
FLTA28100800	100x80	155	136	80	76